

# Distal Femoral Replacement

Surgical Technique:  
Passive Rotating Hinged Tibia  
Option

---



973.264.5400

[onkossurgical.com](http://onkossurgical.com)

Precision Orthopaedic Oncology

- ELEOS™ Limb Salvage Solutions
- My3D® Personalized Solutions
- GenVie® Regenerative Biologics



# 1 IMPLANT DESCRIPTION & INDICATIONS

## **1.1 Implant Description:**

Onkos Surgical Specific Devices are manufactured in accordance with an approved prescription for a named patient. They **MUST NOT** be used for any other patient.

The patient name is detailed in the operation drawing supplied with the device/s.

**The planned resection levels are indicated on the operation drawing supplied with the implant.**

Before commencing surgery please refer to packaging insert for complete product information, including contraindications, warnings, precautions, and possible adverse effects/complications. Packaging Inserts are also available from Onkos Surgical.

## **1.2 Implant Intended Use:**

Patient Specific Implants are indicated for limb sparing and skeletal restorative procedures where radical resection and replacement of the distal femur is required with the following conditions:

- Patients suffering from severe arthropathy of the distal femur that do not respond to any conservative therapy or better alternative surgical treatment
- Surgical intervention for severe trauma, revision arthroplasties, failed previous prostheses and/or oncology indications; and malignant diseases (e.g. osteogenic sarcoma).

Onkos Surgical Patient Specific Devices and their components are for single use only.

## **1.3 Indications:**

- Primary bone tumors
- Secondary tumors arising in bone
- Non-neoplastic conditions affecting the shafts of long bone
- Failed joint replacements
- Failed massive replacements

Onkos Surgical Specific Devices are indicated for cemented and cementless procedures where radical resection and replacement of the distal femur is required.

## **1.4 Contraindications:**

Absolute contra-indications include:

- Infection and sepsis.

Relative contra-indications include:

- Long delay between manufacturing and insertion of a patient specific implant may result in significant mismatch due to possible changes in bone geometry
- Inadequate or incomplete soft tissue coverage
- Uncooperative or unwilling patient or patient unable to follow instructions
- Foreign body sensitivity. Where materials sensitivity occurs seek advice with respect to testing
- Obesity
- Vascular disorder, neuromuscular disorders or muscular dystrophy.

## **1.5 Patient Selection:**

Factors to be considered:

- Resection of neoplastic or diseased bone
- At risk from pathological fracture
- Pain relief and improved function
- Ability of patient to willingly follow instructions and undergo rehabilitation

Onkos Surgical Specific Devices are available for use with the following tibial configuration options:

- Rotating hinge – Passive tibia
- Passive fixed hinge tibia
- Rotating hinge – polyethylene tibia
- Rotating hinge – Metal cased tibia
- Fixed hinge tibia

The rotating hinge polyethylene tibial option is suitable for routine cases, the rotating hinge metal cased tibial option is suitable for extra-articular resection or difficult revisions and the fixed hinge tibial option is suitable for knees with marked instability.

# 2 EXPLODED VIEW

---

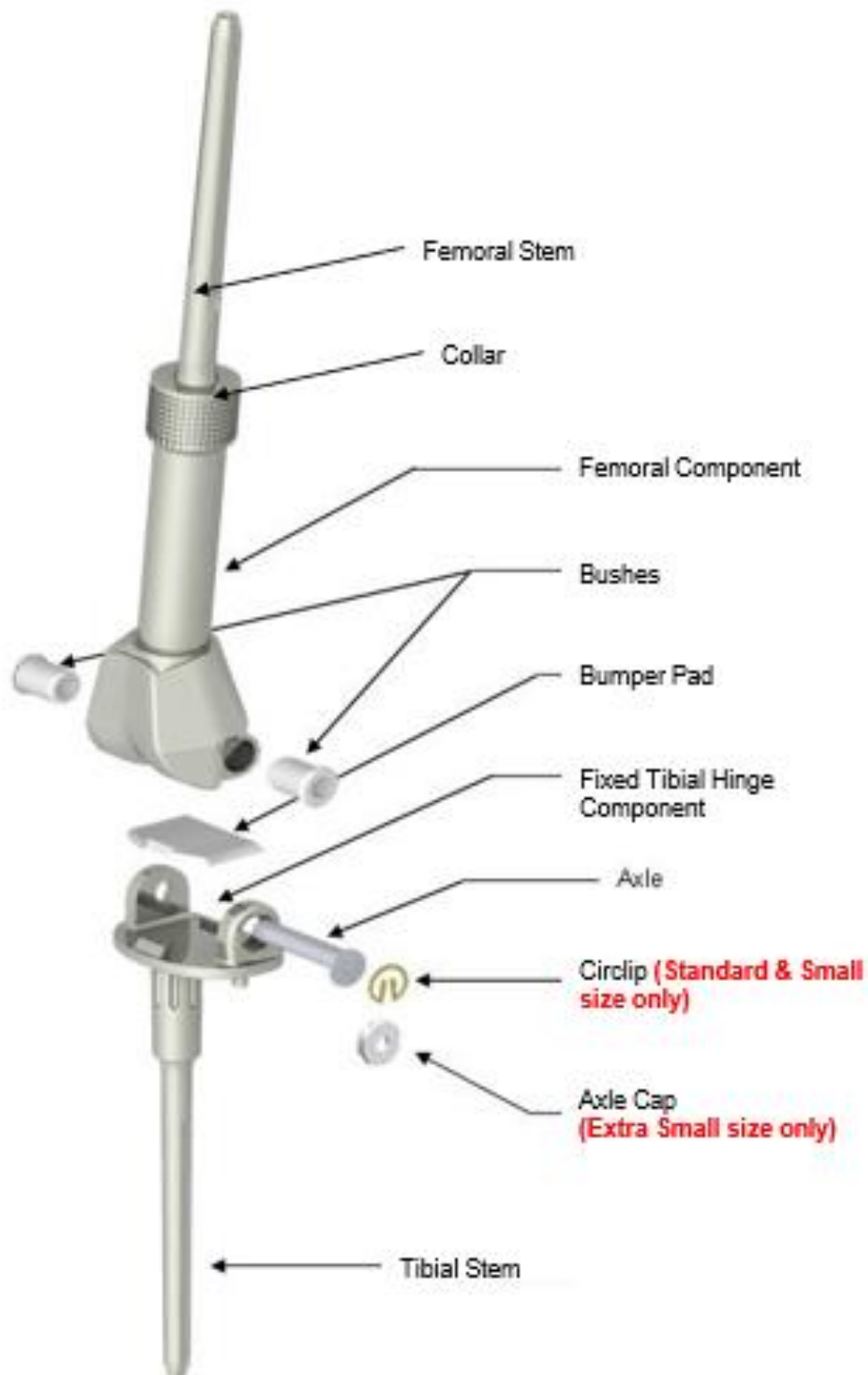

# 3 INSTRUMENTS

---



General Impactor



Anti-Rotation Lug Drill



Hole Cutting Guide

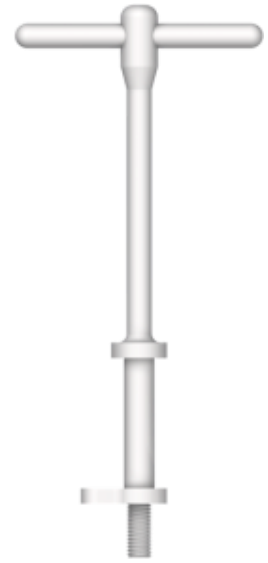

Bush Compressor

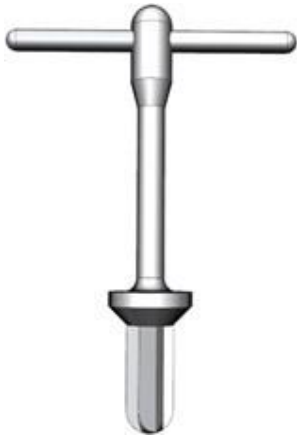

Fixed Hinge Tibial Reamer



Circlip Pliers  
**(Standard & Small size only)**



Axle-Cap Introducer  
**(Extra Small size only)**



Hammer



Tibial Hole Cutting Guide Pins



Tibial Cutting Guide



# 4 TIBIAL PREPARATION

---



Adjust prongs of tibial cutting guide to sit on the plateau of the tibia

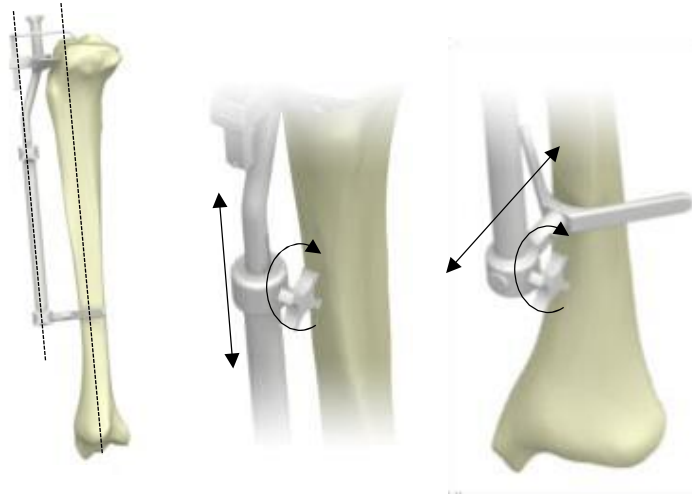

Align cutting guide to be parallel with tibia and secure adjustments using locking screws

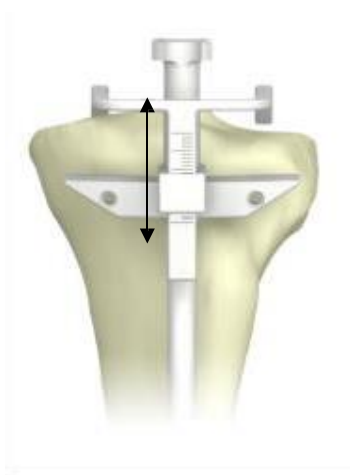

Adjust the reference cutting face to match the depth indicated on the operation drawing

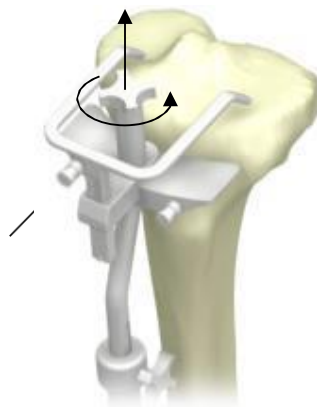

Secure the reference cutting face using bone pins and remove prong assembly



Trim tibial plateau in line with plane of reference cutting face

# 5 TIBIAL INSERTION

---



Secure cutting guide with pins, aligning straight edge with posterior of tibia

Ream tibial canal using fixed hinge tibia reamer

Use AR Lug drill to make two 10mm deep holes as indicated by cutting guide

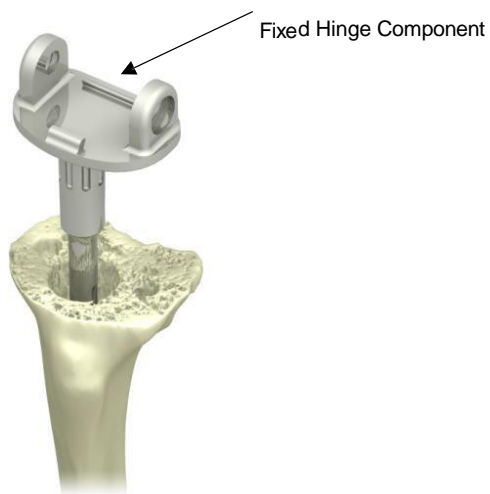

Remove cutting guide and cement in fixed hinge tibia

**Note:** If optional plateau plate is to be used, it should be cemented with a thin layer of cement to the underside of the tibial component prior to impacting tibial component into tibia

# 6 BUMPER PAD & BUSHES

---



Insert bumper pad, aligning curve and anterior edge under anterior rail of tibial component



Use general impactor to clip posterior edge of bumper pad into place

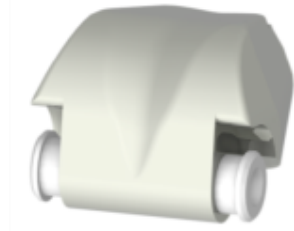

On the femoral component, insert bushes into either end as far as possible



If not seated fully, use bush compressor to fully seat the bushes



Slide in from one side and screw in nut until bushes are fully seated

# 7 FEMORAL INSERTION

---

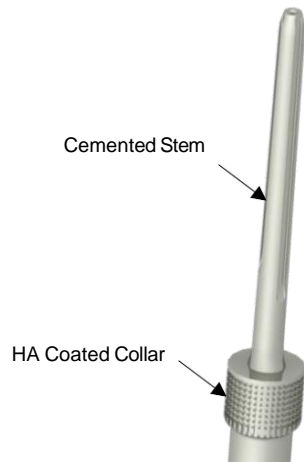

When cementing the femoral component into the femur, ensure that no cement adheres to the HA coated collar. Failure to do so may result in poor bony ingrowth.

It is advised to use a cement restrictor where possible.

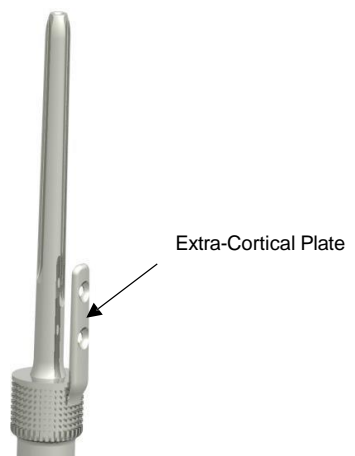

If the femoral component has an extra-cortical plate incorporated into the shaft, implant grade titanium alloy  $\text{Ø}4.5\text{mm}$  cortical bone screws of appropriate length (selected by the surgeon) may be used in the screw holes.



# 8 AXLE INSERTION

---



Align femoral and tibial component.  
Insert axle from either side



Using pointed implement, rotate axle  
to ensure offset head fits into recess  
within tibial component

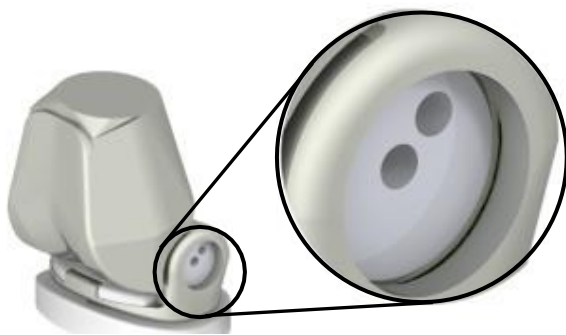

Ensure offset head is seated within recess and not  
trapped in circlip groove

# 9 CIRCLIP INSERTION

**(Standard & Small Size Only)**

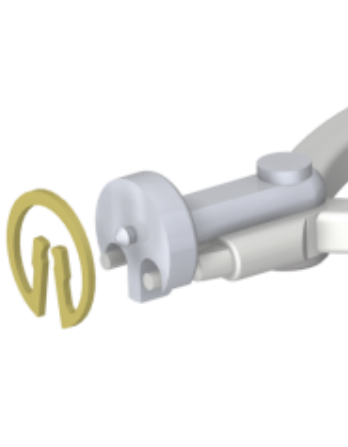

Align opening of circlip with prongs of circlip pliers

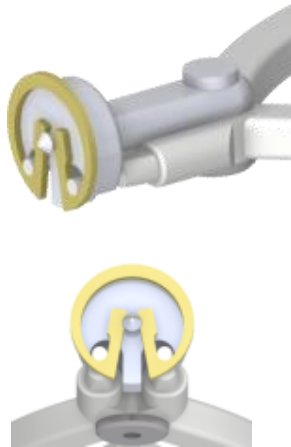

Push circlip onto pliers, locating central locating pin into centre of circlip. Ensure prongs of pliers are oriented as shown



Engage circlip by approaching at an angle, from same side as axle insertion



Squeeze the circlip pliers to close the circlip. Insert circular edge within groove in tibial component



Straighten out to engage circlip into groove

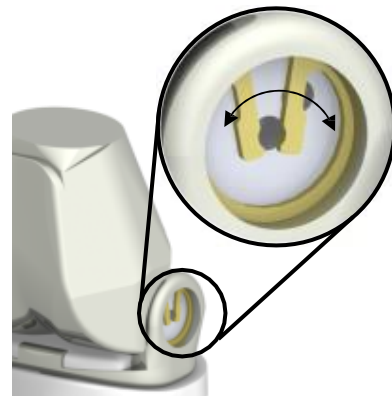

Once within groove, release grip on pliers to secure circlip within groove. Rotate circlip within groove, to ensure correct fit.

# 10 AXLE CAP INSERTION

---

## (Extra Small Size Only)

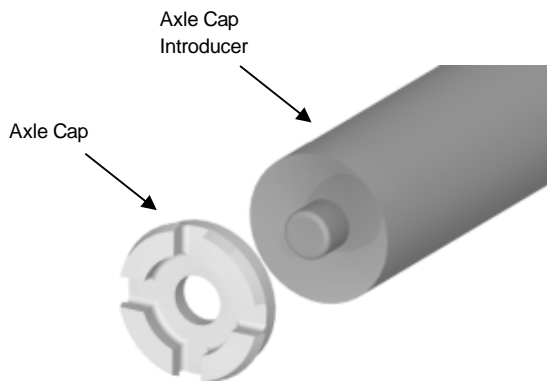

Orientate axle cap with flanges away from axle cap introducer

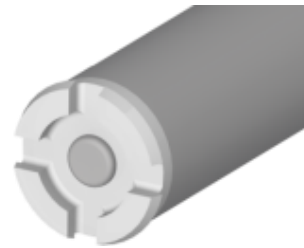

Press axle cap firmly onto introducer



Insert axle cap by approaching from same side which axle was inserted



Press in fully until flanges click into groove on tibial component



Onkos Surgical  
77 East Halsey Road  
Parsippany, NJ USA 07054  
+1-973-264-5400  
[www.onkossurgical.com](http://www.onkossurgical.com)



IdealMed Ltd, Unit A2,  
Beech House Oaklands  
Office Park, Hooton  
Cheshire, CH66 7NZ,  
United Kingdom

All trademarks are the property of **ONKOS SURGICAL** unless otherwise indicated. A surgeon should rely exclusively on his or her own professional medical/clinical judgment when deciding which particular product to use when treating a patient.

**ONKOS SURGICAL** does not prescribe medical advice and advocates that surgeons be trained in the use of any particular product before using it in surgery. A surgeon must always refer to the package insert, product label and/or instructions for use before using any **ONKOS SURGICAL** product.

PS DFPRH ST 06.16.23 v0

©2023 ONKOS SURGICAL. All rights reserved.

