

ELEOS™

Limb Salvage System

Surgical Technique: ELEOS™ Total Femoral Replacement

The ELEOS Limb Salvage System offers options for patients with significant bone loss due to cancer, trauma, or previous surgical procedures. The locking taper design has a history of clinical use in a variety of orthopaedic applications. With an array of options in a multitude of sizes, the ELEOS system provides the surgeon the ability to meet a variety of patient needs.

973.264.5400

onkossurgical.com

Precision Orthopaedic Oncology

- ELEOS™ Limb Salvage Solutions
- My3D® Personalized Solutions
- GenVie™ Regenerative Biologics



Table of contents

ELEOS™

Limb Salvage System

Total Femoral Replacement



Set configurations.....	4
Component overview	4
Construct overview	8
Surgical technique steps.....	9
Tibial Preparation	9
• Tibial reaming	9
• Tibial resection	10
• Tibial stem extensions (optional)	11
Tibial baseplate preparation	12
• Tibial baseplate reaming.....	13
• Tibial baseplate keel punch	13
Acetabular preparation.....	13
Femoral component sizing.....	13
Trialing.....	14
• Trial assembly	14
• Proximal femur trial assembly.....	14
• Midsection and distal femur trial assembly	14
• Tibial trial assembly	15
• Trial reduction	15
Component assembly	16
• Femoral component.....	16
• Tibial component	16
• Tibial baseplate tapered screw (optional) ..	17
Cement preparation	18
Component insertion.....	18
• Tibial component	18
• Femoral component.....	18
• Femoral head assembly	18
Tibial hinge assembly	19
Patella reconstruction (optional)	20
Block augments (optional)	22
Suture Technique.....	23
Component disassembly	24
Explantation information	24

Set configurations

Please refer to document CORP 06.02.21 Total Femur Set Configurations for a full listing of implant and instrument set requirements, images, and part listings

Component overview

The ELEOS™ Total Femoral System consists of 10 components: Femoral Head, Proximal Femur, Midsections, Distal Femur, Axial Pin, Tibial Hinge Component, Tibial Polyethylene Spacer, Tibial Baseplate, Optional Tapered Screw, and Optional Stem Extension.

Femoral heads

Cobalt-chrome Femoral Heads are available in 22.25mm, 28mm, 32mm, and 36mm diameters as shown in Table 1, and are compatible with MicroPort Orthopedics' Gladiator Bipolar and Lineage Acetabular Systems. Refer to the ELEOS Limb Salvage System Instructions for Use for compatibility information.

➤ Note: MicroPort Orthopedics ceramic femoral heads in 28, 32, and 36mm diameters are compatible with the ELEOS System if a ceramic head is indicated.

Table 1.

Neck Lengths						
Head Ø	Material	-3.5mm	+0mm	+3.5mm	+7mm	+10.5mm
22.25mm	Co-Cr		x	x		
28mm	Co-Cr	x	x	x	x	x
32mm	Co-Cr	x	x	x	x	
36mm	Co-Cr	x	x	x	x	

Proximal femur

The ELEOS Proximal Femur offers total bone replacement of 104mm to 244mm when measured from the center of a +0mm Femoral Head as shown in Table 1. The ELEOS proximal femur is offered in a left and right implant as shown in Table 2. The implant features a 135° neck angle, 15° of anteversion, anatomically aligned suture holes, and lateral plasma spray coating.

Table 2.

Proximal Femur Component Length	
Part #	Description
PF-2000R-02M	Segmental Proximal Femur, Plasma Spray, 98mm, Right
PF-2000L-02M	Segmental Proximal Femur, Plasma Spray, 98mm, Left

Component overview

Optional midsections

Seven lengths of optional Male/Female (M-F) Midsection components are interchangeable with all ELEOS™ systems to allow for precise length determination intraoperatively. Lengths ranging from 40–70mm in 10mm increments in addition to 90mm, 110mm, and 140mm to accommodate femoral replacement as shown in Table 3. Male/Male (M-M) Midsections are also available with male tapers on both ends in lengths ranging from 40–70mm in 10mm increments enabling the implantation of a Total Femoral Replacement by combining the ELEOS Proximal and Distal Femur components. Various configurations of Male/Male and Male/Female Midsections can be coupled to produce the desired resection and overall construct length. | Table 4

Table 3.

Male/Female Midsections		
Part #	Description	Style
25001040E	40mm	M-F
25001050E	50mm	M-F
25001060E	60mm	M-F
25001070E	70mm	M-F
25001090E	90mm	M-F
25001110E	110mm	M-F
25001140E	140mm	M-F

Table 4.

Male/Male Midsections		
Part #	Description	Style
MS-040MM-02M	40mm	M-M
MS-050MM-02M	50mm	M-M
MS-060MM-02M	60mm	M-M
MS-070MM-02M	70mm	M-M

Distal femur

The Distal Femur features a deepened patellar groove and a 5° valgus angle to assist in the restoration of patello-femoral kinematics, reduction of patellar subluxation, and promotion of normal loading patterns. Implant details are shown in the table below. | Table 5

Table 5.

Distal Femur		
Part #	Description	Size
25000007E	Distal Femur Left, Segmental	65mm
25000009E	Distal Femur Right, Segmental	65mm
25002111E	Distal Femur Axial Pin	N/A

Component overview

Tibial spacer and hinge

The Tibial Polyethylene Spacer is available in 8mm, 10mm, 12mm, 16mm and 20mm heights as shown in Table 6. The Tibial Hinge Component is inserted into the Tibial Polyethylene Spacer and is offered both with and without a rotational stop | Table 6. Internal/external rotation of the hinge can be controlled with the component that has the rotational stop, which is set for +/- 15°.

Table 6.

Tibia Polyethylene Spacer		
Part #	Description	Size
25001208E	Tibial Poly Spacer	8mm
25001210E	Tibial Poly Spacer	10mm
25001212E	Tibial Poly Spacer	12mm
25001216E	Tibial Poly Spacer	16mm
25001220E	Tibial Poly Spacer	20mm
THSMWRS01M	Tibial Hinge Component With Rotational Stop	One size
THSMWOS01M	Tibial Hinge Component Without Rotational Stop	One size

Tibial baseplate and tapered screw

The Tibial Baseplate is available in five sizes for optimal tibial coverage as shown in Table 7. An optional tibial baseplate tapered screw may be used to further reinforce the construct. Please see optional step on page 17.

Table 7.

Tibial Baseplate		
Part #	Description	Size
TB-2201E-01M	Tibial Baseplate Size 1	60mm M/L
TB-2202E-01M	Tibial Baseplate Size 2	65mm M/L
TB-2203E-01M	Tibial Baseplate Size 3	70mm M/L
TB-2204E-01M	Tibial Baseplate Size 4	75mm M/L
TB-2205E-01M	Tibial Baseplate Size 5	80mm M/L
KSC01500E	Modular Tibial Base Stem Cap	One size
TB-TSCRW-01M	Tibial Baseplate Tapered Screw	One size

Component overview

Stem extensions

The Tibial Baseplate accepts cemented and canal filling Stem Extensions in a variety of lengths and diameters. | Table 8

Table 8.

Stem Extensions – Cemented				
Stem	Description	Length	Diameter	Collar
KSC01530E	Straight Cylindrical, Fluted, Titanium (bullet tip)	30mm	15mm	None
KSC0(XX)65E	Straight Cylindrical, Fluted, Titanium	65mm	10, 12, 14, 16mm	None
KSC(XX)100E	Straight Cylindrical, Fluted, Titanium	100mm	10, 12, 14, 16, 18mm	None
Stem Extensions – Canal Filling				
KSP(XX)100E	Straight, Cylindrical, Splined, Slotted, Titanium	100mm	11, 12, 13, 14, 15, 16, 17, 18, 19, 21mm	None
KSP(XX)140E	Straight, Cylindrical Splined, Slotted, Titanium	140mm	11, 12, 13, 14, 15, 16, 17, 18, 19, 21mm	None

Block augments

The Tibial Baseplate also accepts Block Augments that can be independently placed on the medial or lateral compartment to address specific patient bone deficiencies. | Table 9

Table 9.

Block Augments		
Part #	Description	Size
KTAGB(XXX)E	ELEOS™ Tibial Block Augment	(1, 2, 3, 4, 5) X (5, 10, 15mm)

Construct Overview^{1,2}

Construct length determination

The general equation for identifying the components needed to achieve a given total femoral construct length is shown here. | Table 10

Table 10.

Examples of how to measure a full assembly: (all figures in mm)

M/M Length	+	M/F Length (1)	+	M/F Length (2)	+	Distal Femur Length	+	Proximal Femur Length	+	# of taper gaps	=	Total Construct Length
------------	---	----------------	---	----------------	---	---------------------	---	-----------------------	---	-----------------	---	------------------------

Here are two examples of how to measure a Total Femoral Construct length:

Example 1: Using one (1) M-F midsection for a targeted replacement of 296mm

$$40\text{mm M-M} + 90\text{mm M-F} + 65\text{mm DF} + 98\text{mm PF} + 3\text{mm} = 296\text{mm total length}$$

Example 2: Using two (2) M-F midsections for a targeted replacement of 327mm

$$40\text{mm M-M} + 40\text{mm M-F} + 90\text{mm M-F} + 65\text{mm DF} + 98\text{mm PF} + 4\text{mm} = 337\text{mm total length}$$

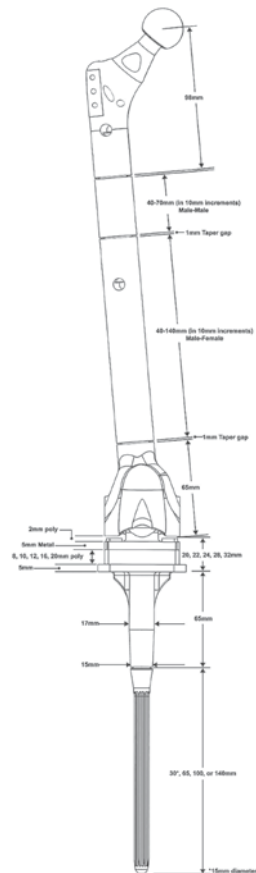
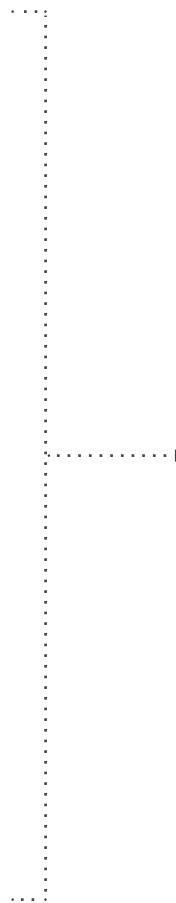

¹ The 20mm tibial resection is necessary with an 8mm spacer and the thickness of the Tibial Hinge Component (5mm metal and 2mm poly). The actual resection can be less depending on joint line positioning and ligament compliance.

² Two 40mm Midsections are available to achieve desired resection lengths in 10mm increments.

Surgical technique steps

Tibial preparation

The tibial resection is performed using Intramedullary (IM) Referencing Instrumentation. Consider that the Tibial Components (Tibial Baseplate, Tibial Polyethylene Spacer, and Tibial Hinge Component) will add 20mm of length when using an 8mm spacer; confirm that enough tibial bone is removed.

- Note: The ELEOS™ Tibial Implants are designed for a perpendicular tibial base orientation to the IM canal. Hence, IM instrumentation helps ensure a neutral resection.

Tibial reaming

- 1 Initiate an opening in the proximal tibia with the 3/8 in. Starter Drill Bit. The opening should be slightly posterior to the anterior cruciate ligament tibial attachment.
- 2 Attach the Quick Disconnect T-handle to the 11 in. Reamer/IM Rod.
- 3 Ream to establish the anatomical axis of the proximal tibia and to allow for the assembly of the IM Tibial Alignment Guide. | Figure 1
- 4 Drill to approximately 1 to 1.5 inches in depth.
- 5 Toggle the drill to increase the opening diameter. Remove the T-Handle quick connect, leaving the reamer shaft/IM Rod in the bone.

- Note: If using a Stem Extension, continue reaming with consecutive larger reamer diameters until the desired canal diameter is achieved. This is ideally done after making the tibial resection.

- Caution: Hand reaming is recommended when a patient has poor bone quality.

Figure 1



Surgical technique steps

Tibial resection

- 1** Preassemble the IM Tibial Alignment Guide and IM Tibial Resection Guide on the back table.
- 2** Remove the T-Handle from the 11 in. Reamer/IM Rod.
- 3** Slide the IM Tibial Alignment and Resection Guide assembly onto the 11 in. Reamer/IM Rod until the bottom surface of the guide rests against the tibial surface | Figure 2.
- 4** Turn the locking screw to lock the guide to the 11 in. Reamer/IM Rod A as shown in Figure 2.
- 5** Use the Depth Stylus and/or Dual Reference Gauge (also known as crab claw/angel wing) to set the proximal/distal position of the IM Tibial Resection Guide to the desired level of tibial resection B as shown in Figure 2. The Depth Stylus can be set to measure a depth of resection of 2mm or 10mm.
 - Note: The IM Tibial Resection Guide can be moved an additional 3mm down if the initial pin is placed in the "0" hole to get the desired resection level.
- 6** After desired resection level is achieved, tighten the knob on the IM Tibial Resection Guide C as shown in Figure 2.
- 7** Secure the IM Tibial Resection Guide to the proximal tibia using the Headless Fixation Pins. Pin the IM Tibial Resection Guide to the proximal tibia.
- 8** After the desired alignment is achieved and pins are in place, loosen the locking screw A as shown in Figure 2 and loosen knob on the IM Tibial Resection Guide C as shown in Figure 2.
- 9** Remove the top of the IM Tibial Alignment Guide leaving the IM Tibial Resection Guide pinned into the tibia.
- 10** Make the tibial resection and remove the IM Tibial Resection Guide.

Figure 2

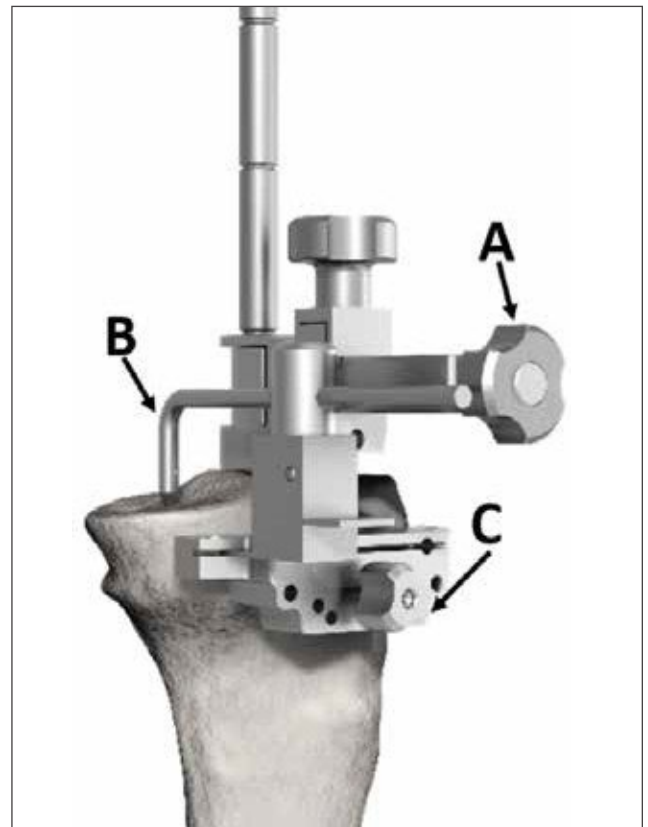

Surgical technique steps

Optional

Tibial stem extensions

- 1 Utilize the Cylindrical Reamer to continue preparing the tibial canal for the Stem Extension.
 - 2 If the tibial resection has been completed, ream to the appropriate depth of the tibial construct as shown in Figure 3 in red.
 - 3 If the tibial resection has not been completed, ream approximately 20mm beyond that distance, as shown in Figure 3 in green. This depth accounts for the Tibial Baseplate tray, general Poly Spacer, and Tibial Hinge Component.
- Note: Consider an additional 20mm to account for the placement of a cement restrictor in the distal end of the prepared tibial canal.
- 4 When desired reaming is complete, ensure that the Reamer provides a stable construct for additional tibial preparation.
- Caution: Hand reaming may be appropriate to avoid thinning the tibial cortex which could result in a fracture.
- Note: The Stem Extension diameters from Table 8 are equal to Reamer diameters. When determining the appropriate Cylindrical Reamer size for the desired cement mantle, the difference will represent the cement mantle. For instance, reaming to a 13mm diameter will provide a line-to-line fit with a 13mm stem. Reaming to a 14mm will provide a 0.5mm cement mantle per side, while reaming to 15mm will provide a 1mm cement mantle per side. When determining the appropriate Cylindrical Reamer size for the canal filling stems, the difference will represent the fit. For instance, reaming to a 13mm diameter will provide a line-to-line fit with a 13mm stem, while reaming to 12mm will provide a 1mm press fit.

Figure 3



Table 11

Stem Extension	Resected (Red Line)	Unresected (Green Line)
30mm	Top of reamer threads	Between 65mm letters
65mm	Top of 65mm etching	Between 100mm letters
100mm	Top of 100mm etching	Between 140mm letters
140mm	Top of 140mm etching	20mm past top of 140mm

Surgical technique steps

Tibial baseplate preparation

- 1** Select the Trial Tibial Baseplate Template that provides the optimal proximal tibial bone coverage. | Figure 4
- 2** Place the Trial Tibial Baseplate Template on the proximal tibia.
 - ▶ Note: If using Tibial Augments, see “Block Augments (Optional)” and attach the appropriate size and thickness Trial Augment to the Trial Tibial Baseplate Template.
 - ▶ Note: To ensure optimal Trial Tibial Baseplate Template sizing and location, place the template over the Cylindrical Reamer. Slide the Trial Tibial Base Handle/Drill Guide over the reamer until it interfaces with the template, centering the template on the tibial canal. | Figure 4
- 3** Change the template size if required to optimize proximal tibial bone coverage. | Figure 4
- 4** If the size is appropriate, align the baseplate using the Trial Tibial Base Handle/Drill Guide and External Check Rod and pin it to the tibia using Headed Pins. | Figure 5
 - ▶ Note: Align the distal end of the External Check Rod with the second toe.
- 5** Remove the Tibial Baseplate Handle and External Check Rod. Loosely attach the Keel Punch Guide Handle to the Keel Punch Guide.
- 6** Align the pegs on the bottom of the Keel Punch Guide to the center holes in the Trial Tibial Baseplate Template.
- 7** Secure the Keel Punch Guide to the Trial Tibial Baseplate. Turn the knurled handle, ensuring that the Keel Punch Guide Handle is in the correct orientation A as shown in Figure 6.

Figure 4

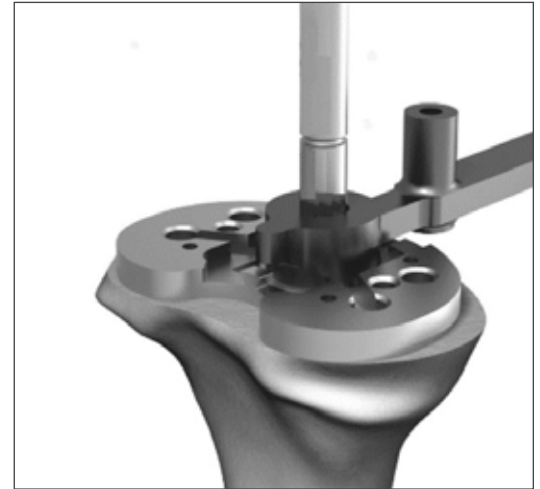

Figure 5



Figure 6



Surgical technique steps

Tibial baseplate reaming

- 1 Align the Press Fit Reamer Guide or Cemented Reamer Guide through the Tibial Baseplate Punch Guide.
- 2 If a thin cement mantle is preferred, utilize the Press Fit Reamer Guide and Press Fit Reamer; if a thicker cement mantle is preferred, use the Cemented Reamer Guide and Cemented Reamer.
- 3 Using the appropriate reamer, ream until no teeth are visible above the Reamer Guide. | Figure 7
 - ▶ Note: Make certain that the Tibial Baseplate Template stays flush to the resection steps during the reaming and punching steps.
- 4 Remove the Reamer Guide from Keel Punch Guide.

Figure 7

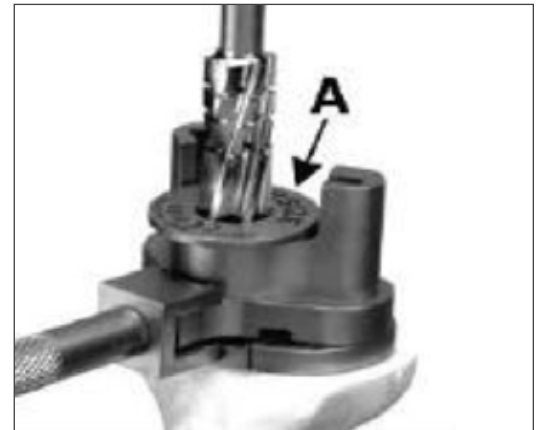

Tibial baseplate keel punch

- 1 Using the Keel Punch Impactor and the Press Fit or Cemented Keel Punch, slide the punch through the guide until the punch is fully seated. The Keel Punch is fully seated when the knurled handle is flush against the guide, which acts as a positive stop. | Figures 8 and 9. If Stem Extension reaming was performed, attach the appropriate size Trial Stem Extension to the chosen Keel Punch.
- 2 Disassemble and remove all tibial preparation instruments. Use the Pin Puller to remove fixation pins

Figure 8



Figure 9



Acetabular preparation

- 1 Use a compatible acetabular system and prepare the acetabulum with the standard technique.

Femoral component sizing

- 1 Measure the amount of femoral bone to be replaced in order to select the appropriate Midsection length. It is possible to use multiple Midsections as is required to restore leg length.

Surgical technique steps

Trialing

Trial assembly

Trial assembly requires the following appropriate components:

- Trial Femoral Head
- Trial Proximal Femur
- Trial Male/Male Midsection and Male/Female Midsection Trial(s) necessary to reproduce the appropriate leg length
- Trial Distal Femur
- Trial Hinge Component With Trial Axial Pin
- Trial Tibial Poly Spacer
- Trial Tibial Baseplate (and, if used, Trial Stem Extension)

Proximal femur trial assembly

The Trial Proximal Femur requires orientation based on the side of the body being treated, right or left.

- 1 Pull apart the proximal neck and quick release portions of the Trial Proximal Femur to allow setting of the directional anteversion configuration. While separated, twist the directional tab toward either the right or left marking, sliding the tab into the chosen slot. | Figure 10

Midsection and distal femur trial assembly

- 1 Assemble the Trial Distal Femur and the Trial Midsections necessary to reproduce appropriate leg length as shown in Figure 11. To assemble the trials, lift the sliding portion of the quick connect mechanism of the Trial Hinge Component, engage the post, align the tab with the slot, then release.

Figure 10



Figure 11

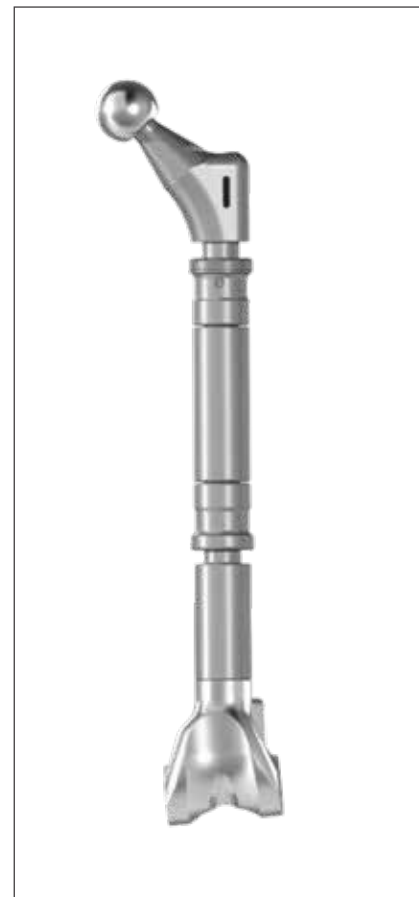

Surgical technique steps

Tibial trial assembly

- 1** Assemble the Trial Tibial Baseplate, Trial Stem Extension (optional), Trial Tibial Poly Spacer, and Trial Tibial Hinge Component according to previously determined sizes chosen. | Figures 12–14
 - 2** Insert the Trial Tibial Hinge Component assembly into the tibia as shown in Figure 13. Reduce the trial femoral construct onto the Trial Hinge Component.
 - 3** Insert the Trial Axial Pin to attach the Trial Distal Femur to the Trial Tibial Hinge Component to secure the construct for trial reduction. | Figure 14
- Note: The Trial Axial Pin can be inserted from the medial or lateral side.

Trial reduction

- 1** Perform a trial reduction.
- 2** If the overall leg length requires adjustment or soft tissue tensioning, adjustments may require altering the choice of Femoral Head or Midsection Trials.

Figure 12



Figure 13



Figure 14



Surgical technique steps

Component assembly

Femoral component

- 1 On the back table, place the Distal Femur and Male-Female Midsection(s) in the Femoral Assembly Platform using the Trial Axial Pin.
 - 2 Assemble with five hard mallet blows using the Midsection Assembly Impactor. | Figure 15
 - 3 Place the desired Male-Male Midsection on the Male-Female Midsection and place the Proximal Femur on the Distal Femur/Midsection assembly. Using the Femoral Impactor, assemble the total femur with five hard mallet blows. | Figures 16 and 17
- Caution: Mallet assembly must be performed over or near the support legs of a rigid back table and not on an unstable surface such as the mayo stand. Ensure that the components are free from debris and dry prior to assembly. If required, wipe/dry components with a sterile lap sponge.

Tibial component

- 1 If not using a Stem Extension, insert the Poly Plug included in the Tibial Baseplate package into the distal taper. Alternatively, a Modular Tibial Base Stem Cap (KSC01500E) can be inserted and impacted using the instructions for a Stem Extension. This will prevent cement from extruding into the implant during insertion.

If using a Stem Extension, place the Tibial Baseplate on the Tibial Baseplate Assembly Platform. A marking on the anterior portion of the Tibial Baseplate boss provides a reference to align the slot of the Stem Extension when a canal filling stem is indicated. | Figure 18

➤ Note: The slot on the Stem Extension B shown in Figure 18 should align with the marking on the Tibial Baseplate boss A shown in Figure 18.

- 2 Assemble the Stem Extension onto the Tibial Baseplate using five hard mallet blows directly on the tip of the Stem Extension with the Stem Assembly Impactor. | Figure 19

➤ Note: Make sure to remove the protective cap on the tip of the Stem Extension before assembly.

If augments are to be used, see "Block Augments (Optional)."

Figure 15



Figure 16



Figure 17



Figure 18

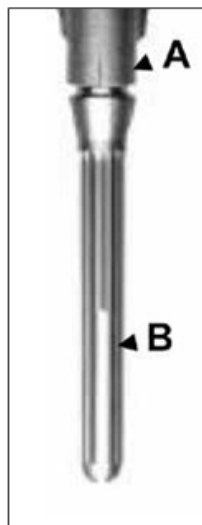

Figure 19



Surgical technique steps

Optional Step

Tibial Baseplate Tapered Screw

1. Assemble the Extension Driver shaft to the Screwdriver Handle.

Note: Confirm that the proper Tapered Screw has been selected. The Tibial Baseplate Tapered Screw is 16.5mm in length and the Resurfacing Femur Tapered Screw is 25.5mm in length. They are not cross-compatible.

Insert the Tibial Baseplate Tapered Screw into the Tibial Baseplate chamber. Using the driver, hand tighten the Tibial Baseplate Tapered Screw into the threads of the assembled Stem Extension. | Optional Step: Figure 1

Remove the Extension Driver from the Tibial Baseplate.

2. Assemble the second Extension Driver Shaft to the Torque Wrench. Insert the Tibial Baseplate and Stem Extension into the Counter Torque Instrument by sliding the stem extension into the Tibial Baseplate side of the Counter Torque Instrument. | Optional Step: Figure 2.

3. Ensure the Tibial Baseplate keel is aligned with the slots in the Counter Torque Wrench and that the Tibial Baseplate is fully seated against the surface. | Optional Step: Figure 3

4. Insert the assembled Torque Wrench and Extension Driver shaft into the chamber until it engages with the head of the screw. Turn until the Torque Wrench clicks (8 Nm) indicating that the tightening torque has been reached | Optional Step: Figure 4

5. Remove the Torque Wrench from the Tibial Baseplate and the Tibial Baseplate assembly from the Counter Torque Instrument.

Note: If using Tibial Augments, see "Block Augments (Optional)" on page 22.



Optional Step: Figure 1



Optional Step: Figure 2



Optional Step: Figure 3



Optional Step: Figure 4

Surgical technique steps

Cement preparation

- 1 Remove trial components from the femoral and tibial regions.
- 2 Prepare the canal for cement by first cleaning the canal with pulsating lavage. Dry the canal with desired sponge. If desired, place a cement restrictor into the canal. Inject cement into the canal in a pressurized retrograde fashion.

Component insertion

Tibial component

- 1 Place the tibial component and Tibial Poly Spacer into the canal using the Tibial Impactor. | Figure 20
 - 2 Ensure that final components are anchored in the appropriate position until the cement has set fully.
- ⚠ Caution: If a Stem Extension is not used, ensure that the Tibial Baseplate Poly Plug or Modular Tibial Base Stem Cap is firmly in place prior to insertion.

Femoral component

- 1 Place the assembled Total Femur construct in the soft tissue surrounding the femur to be replaced.

Femoral head assembly

- 1 A final trial reduction may be performed with the 22.25mm, 28mm, 32mm, or 36mm Trial Femoral Heads to ensure precise soft tissue balancing.
- 2 Remove the Trial Femoral Head from the implant. Clean and dry the taper of the Proximal Femur to be free of foreign materials.
- 3 Select the desired Femoral Head. Place the Femoral Head on the femoral stem taper using a slight turning motion. Impact the Femoral Head with the Femoral Head Impactor with five hard mallet blows to achieve final seating. | Figure 21

Figure 20



Figure 21

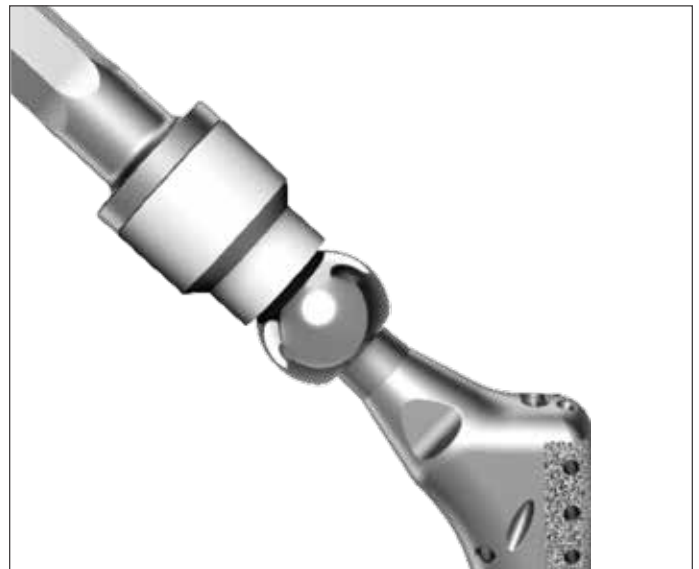

Surgical technique steps

Tibial hinge assembly

- 1** Insert the Tibial Hinge Component into the Tibial Poly Spacer. | Figure 22
- 2** Insert the assembled Tibial Hinge component and Tibial Poly Spacer into the implanted Tibial Baseplate.
- 3** Align the Distal Femur with the Tibial Hinge Component. | Figure 23
- 4** Insert the Distal Femur Axial Pin using the Axial Pin Inserter/Extractor instrument. | Figures 24–26

The Distal Femur Axial Pin can be inserted either on the medial or lateral side. The Axial Pin key must fall into the corresponding keyway in the femoral component. Make sure the Axial Pin is flush with the side of the Distal Femur. | Figure 27

- Note: To help align the components, position the Trial Axial Pin part way into the opposite side you wish to insert the final Axial Pin insertion. Then insert the Axial Pin into the other end and advance the pin forward, ejecting the Trial Axial Pin. Engage the Axial Pin until it is flush on both sides of the Distal Femur.

Figure 22



Figure 23



Figure 24



Figure 25



Figure 26



Figure 27



Surgical technique steps

Optional

Patella reconstruction

The need for patella resurfacing is determined based on the medical judgment of the clinical situation. If severe degeneration or arthritis is present on the articular surface of the patella, resurfacing may be required.

If the patella is otherwise normal, such as in a tumor case, and has not been removed for malignant considerations, it may be acceptable to resurface the patella or to leave it in its natural state.

Resurfacing patella

The Resurfacing Patella Resection Guide can be used with or without Resection Depth Gauges or Minimum Thickness Gauges. When used without gauges, the Resection Guide is positioned at the desired level of resection.

- 1 Securely clamp the jaws into the patella and resect the patellar bone. | Figure 28
- 2 Attach the appropriate Resection Depth Gauge to the top of the resection guide with lock screw to calibrate the resection.
- 3 Position the resection guide jaws parallel to the articular margin and securely clamp the guide to the bone, ensuring that the gauge is contacting the apex of the articular surface.
- 4 Remove the gauge to increase visibility, if needed.
- 5 Assess bone quality and thickness. If deemed adequate, Resurfacing Patella Minimum Thickness Gauges are available for preservation of 10mm or 15mm bone stock. | Table 12

Figure 28



Table 12.

Resurfacing Patella Diameters			
Part #	Description	Diameter	Thickness
KPONT29E	ELEOS™ Resurfacing Patella	29mm	8mm
KPONT32E	ELEOS Resurfacing Patella	32mm	8mm
KPONT35E	ELEOS Resurfacing Patella	35mm	8mm
KPONT38E	ELEOS Resurfacing Patella	38mm	10mm
KPONT41E	ELEOS Resurfacing Patella	41mm	11mm

Surgical technique steps

- 6** Attach the Resurfacing Peg Drill Guide to the Patella Clamp.
 - 7** Size the patella and prepare holes in the bone for the implant pegs using the Resurfacing Pen Drill Guide. | Figure 29
 - 8** Remove the Resurfacing Patella Drill Guide from the Patella Clamp and insert the Patella Clamp Seater in its place.
 - 9** Once the patella surface is prepared, mix the cement, wash and dry the bone, pressurize the cement, and insert the patella pegs into the prepared holes.
 - 10** Use the Patella Clamp with the Patella Clamp Seater attached to fully seat the Patella.
 - 11** Remove residual cement and keep the Patella Clamp in place until cement is cured.
- Note: The Resurfacing Patellae have the same peg patterns between sizes and can be easily changed during trial reduction.
 - Note: A Patella/Femoral Head Sizing Caliper is available for assessment of thickness.

Figure 29

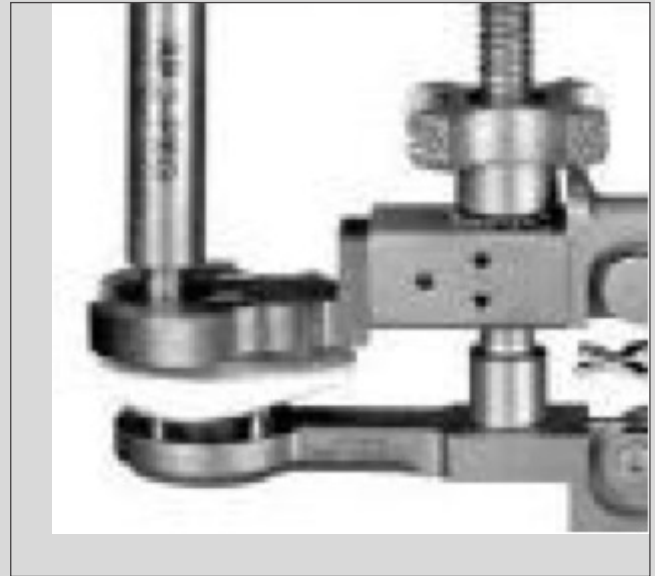

Surgical technique steps

Optional

Block augments

Block augments may be necessary during the Tibial Resection stage.

- 1 Attach the Block Augment Resection Guide to the surface of the tibia.
- 2 Perform a proximal “clean-up” resection along the most prominent condyle through the 0mm resection slot marked “STD” in the Revision Block Augment Resection Guide A as shown in Figure 30.
 - Note: The Revision Block Augment Resection Guide is available in a right- and left-hand version.
- 3 The Revision Block Augment Resection Guide provides resection slots for the 5mm, 10mm, and 15mm augments B as shown in Figure 30.

These augments can be placed independently on the medial or lateral side of the tibia.

- Note: The Revision Block Augment Resection Guide is available in both right- and left-hand versions
- 4 Attach the appropriate size Block Augment to the Trial Tibial Baseplate and proceed with tibial preparation, as specified above.
- 5 During component assembly, attach the augment by aligning the three centering pegs on the Tibial Augment with the three recessed areas of the Tibial Baseplate. | Figure 31
- 6 Assemble the augments to the Tibial Baseplate using the packaged screws. Plastic starter handles are provided with each augment screw and should be removed once the screw is tightened. | Figure 32
- 7 Perform final tightening of the augment with a standard 3.5mm hex head screwdriver.

[Grab your reader’s attention with a great quote from the document or use this space to emphasize a key point. To place this text box anywhere on the page, just drag it.]

Figure 30

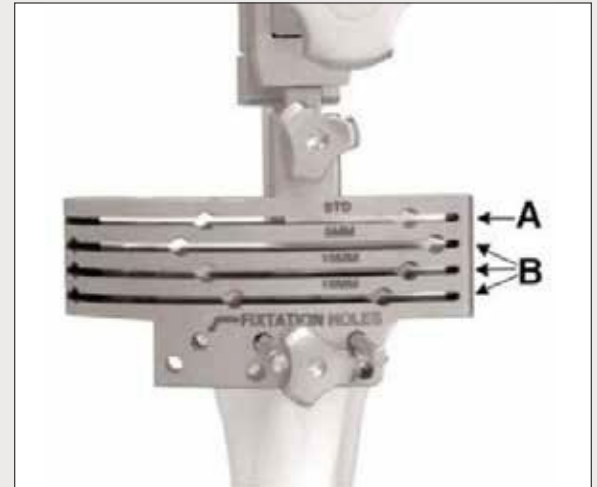

Figure 31

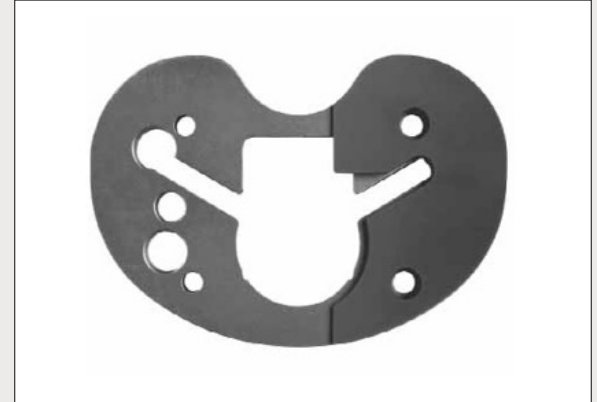

Figure 32



Surgical technique steps

Suture Technique

- 1 Using a heavy non-absorbable suture and a straight needle, advance through the medial superior-inferior hole of the implant from inferior to superior (Point A to Point B). Leave approximately 100mm of suture at point A. (See Figure 33)
- 2 Utilizing a lock stitch, starting medially and underneath on the deep side of the abductor tissue, sew a few locked stitches from distal to proximal exiting out the superficial side of the tissue proximally. Then sew a few locked stitches posteriorly from proximal to distal exiting on the deep side of the tissue distally. (See Figure 34)

- 3 Advance the suture through the posterior superior-inferior hole of the implant from superior to the implant from superior to inferior (Point C to Point D). (See Figure 35)

- 4 Tension suture to approximate the abductors to the implant. At about the level of the middle A/P suture hole, wrap sutures and tie medially around the implant. Then wrap back laterally and tie suture again around the abductors on the lateral side of the implant. An absorbable hemostat can be inserted between the implant and the suture to protect the suture from the plasma coating, if necessary. (See Figure 36)

- 5 If possible, use the most proximal A/P hole to tie down the abductor (See Figure 37). Use the A/P holes to tie the vastus lateralis to the implant. If possible, tie the vastus lateralis to the abductor. Utilize other rotational muscle flaps as necessary to ensure that none of the implant is left exposed.

Figure 33

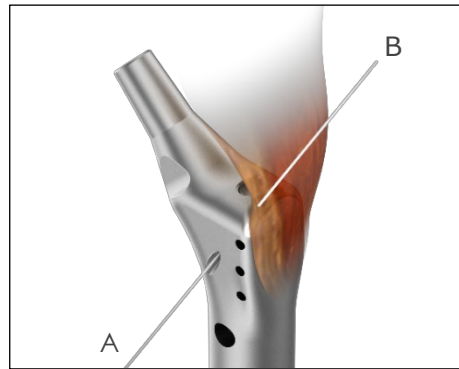

Figure 34

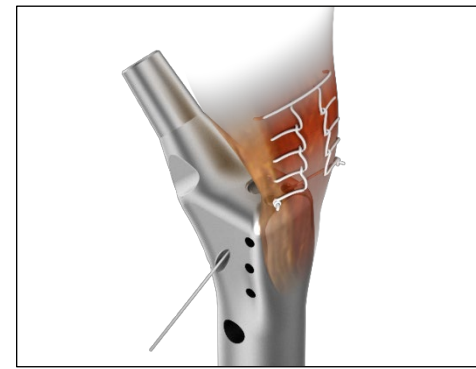

Figure 35

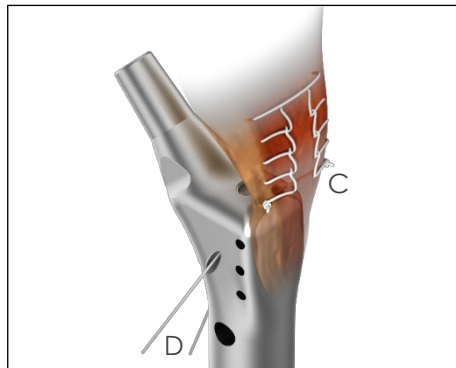

Figure 36

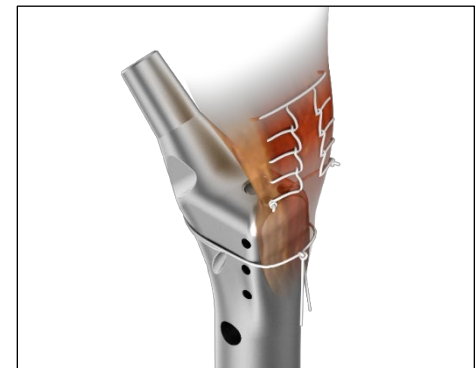
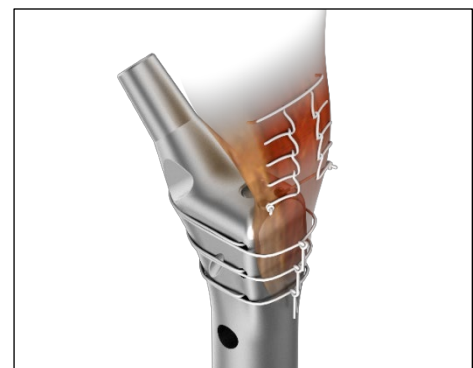

Figure 37



Surgical technique steps

Component disassembly

To disengage the ELEOS™ tapers, insert the Taper Disassembly Tool into the hole on the side of the implant. Strike the end of the tool with a mallet until the components separate as shown in Figure 38. Support the implant during disassembly.

Alternatively, or in concert with the Taper Disassembly Tool, insert the Taper Disassembly Fork around the outside of the implant, below the seam between the two components to be disassembled. Strike the end of the fork to disengage the tapers as shown in Figure 39. Support the implant during disassembly.

Figure 38



Figure 39



Explantation information

To disengage or remove a stem extension, use the Stem Implant Extractor-Adaptor. Assemble it to the Slap Hammer Pin Extractor. Next, thread the full assembly to the Stem Extension that needs to be removed. Alternatively, use a trephine from general surgical instrumentation to remove the Stem Extension. Place the trephine over the Stem Extension to ream the interface between the stem and the bone.

Contact us to learn more:

77 East Halsey Road, Parsippany, NJ 07054

973.264.5400 | onkossurgical.com

The ELEOS™ Limb Salvage System is compatible with the following MicroPort Orthopedics systems trademarked by MicroPort: Guardian, Advance, Gladiator, Lineage, and Transcend.

ONKOS SURGICAL, ELEOS, BioGrip, My3D, GenVie and uDesign are registered marks and trademarks of ONKOS SURGICAL. © 2021 ONKOS SURGICAL. All rights reserved. ELSS TF 08.04.21 v2

